



FORGATTI
v a l e • a l u m í n i o s

CATÁLOGO
PERFIS DE ALUMÍNIO

VIDRO TEMPERADO
E GRADIL

JUNHO / 2020

Índice

CÓDIGO PERFIL	PESO (KG/M)	PÁGINA
BARRAS REDONDAS	-	01
BARRAS QUADRADAS	-	01
BARRAS RETANGULARES	-	01
CANTONEIRAS	-	02
PERFIS T	-	02
PERFIS U DESIGUAIS	-	02
PERFIS U IGUAIS	-	03
TUBOS QUADRADOS	-	03
TUBOS REDONDOS	-	03
TUBOS RETANGULARES	-	04
CHAPA LISA	-	04
CHAPA XADREZ	-	04
A-072	1,210	15
A-096	1,860	15
BG-1000	0,190	08
BX-2899	0,385	08
BX-2900	0,127	08
CG-074	0,275	13
CG-075	0,520	13
CG-077	0,840	13
CG-083	1,403	13
CG-087G	0,430	14
CG-143	2,098	12
CN-4128	1,685	13
CN-4134	0,159	13
CN-4135	0,102	13
COR-101	0,650	12
COR-102	1,050	12
COR-103	1,67	12
D-055	0,497	14
D-082	0,332	14
D-095	0,450	12
D-103	0,760	14
D-143	1,220	14
E-168	0,160	10
E-252	0,140	11
E-306	0,450	07
E-512	0,390	05
E-637A	0,385	07
E-725	0,600	07
F-049	0,120	08
I-083	0,430	08
I-151	0,170	10
I-301	0,162	11
L-001	0,118	11
L-1000	0,270	08
L-382	0,084	11
L-713	1,272	05
U-036	0,108	10

CÓDIGO PERFIL	PESO (KG/M)	PÁGINA
U-037	0,130	10
U-041	0,130	10
U-044	0,151	10
U-163	0,827	11
U-491	0,097	08
U-509	0,192	10
U-555	0,230	10
U-566	0,160	08
U-606	0,154	10
U-607	0,162	10
U-615	0,380	15
U-621	0,265	15
U-877	0,351	15
U-878	0,432	15
U-1014	0,245	08
U-1091	0,788	14
U-1098	0,494	11
U-1108	0,370	07
U-1178	0,135	10
U-1319	0,240	05
U-4814	0,360	10
U-4848	1,500	11
VIT-23	0,273	10
VIT-24	0,190	10
VIT-26	0,195	11
VT-102	0,220	06
VT-104	0,060	08
VT-106	0,600	06
VT-107	0,150	07
VT-108	0,220	07
VT-145	0,687	06
VT-161	0,383	07
VT-215	0,157	07
VT-480	0,130	08
VT-727	0,130	10
VT-2065	0,978	05
VT-2296	0,277	07
VT-2344	0,172	07
VT-2445	0,176	07
VT-2514	0,203	05
VT-2548	0,725	06
VT-3281	0,257	06
VT-3419	0,686	05
VT-3836	0,874	11
Y-343	0,290	10
Y-344	0,250	08
Y-389	0,760	05
KIT DUE	-	09

Barras Redondas

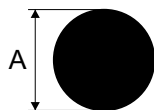

PERFIL	PESO LINEAR KG/M	MM	POLEGADA
		A	A
VER-002	0,086	6,35	1/4
VER-004	0,133	7,93	5/16
VER-007	0,193	9,52	3/8
VER-011	0,342	12,70	1/2
VER-014	0,536	15,87	5/8
VER-016	0,772	19,05	3/4
VER-018	1,050	22,22	7/8
VER-021	1,371	25,40	1
VER-024	1,735	28,57	1.1/8
VER-032	3,078	38,10	1.1/2
VER-040	5,490	50,80	2
VER-042	8,850	63,50	2.1/2
VER-043	12,320	76,20	3

* PARA USINAGEM LIGA 6351 T6

* PARA CAIXILHARIA LIGA 6063 T5

Barras Retangulares

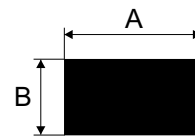

PERFIL	PESO LINEAR KG/M	MM		POLEGADA	
		A	B	A	B
BAR-010	0,082	9,58	3,17	3/8	1/8
BAR-012	0,109	12,70	3,17	1/2	1/8
BAR-047	0,163	12,70	4,76	1/2	3/16
BAR-086	0,217	12,70	6,35	1/2	1/4
BAR-013	0,136	15,87	3,17	5/8	1/8
BAR-049	0,204	15,87	4,76	5/8	3/16
BAR-088	0,272	15,87	6,35	5/8	1/4
BAR-014	0,164	19,05	3,17	3/4	1/8
BAR-050	0,245	19,05	4,76	3/4	3/16
BAR-089	0,326	19,05	6,35	3/4	1/4
BAR-015	0,191	22,22	3,17	7/8	1/8
BAR-052	0,286	22,22	4,76	7/8	3/16
BAR-214	0,135	25,40	2,00	1	-
BAR-016	0,218	25,40	3,17	1	1/8
BAR-053	0,326	25,40	4,76	1	3/16
BAR-091	0,435	25,40	6,35	1	1/4
BAR-129	0,650	25,40	9,52	1	3/8
BAR-019	0,273	31,75	3,17	1.1/4	1/8
BAR-054	0,408	31,75	4,76	1.1/4	3/16
BAR-093	0,544	31,75	6,35	1.1/4	1/4
BAR-022	0,327	38,10	3,17	1.1/2	1/8
BAR-057	0,490	38,10	4,76	1.1/2	3/16
BAR-096	0,653	38,10	6,35	1.1/2	1/4
BAR-134	0,980	38,10	9,52	1.1/2	3/8
BAR-164	1,306	38,10	12,70	1.1/2	1/2
BAR-027	0,436	50,80	3,17	2	1/8
BAR-061	0,653	50,80	4,76	2	3/16
BAR-100	0,870	50,80	6,35	2	1/4
BAR-064	0,816	63,50	4,76	2.1/2	3/16
BAR-032	0,654	76,20	3,17	3	1/8
BAR-068	0,979	76,20	4,76	3	3/16
BAR-106	1,306	76,20	6,35	3	1/4
BAR-144	1,957	76,20	9,52	3	3/8
BAR-175	2,635	76,20	12,70	3	1/2
BAR-036	0,872	101,60	3,17	4	1/8
BAR-110	1,741	101,60	6,35	4	1/4
BAR-149	2,611	101,60	9,52	4	3/8
BAR-180	3,483	101,60	12,70	4	1/2
BAR-114	2,612	152,40	6,35	6	1/4

Barras Quadradas

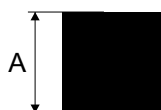

PERFIL	PESO LINEAR KG/M	MM	POLEGADA
		A	A
VER-4002	0,110	6,35	1/4
VER-4003	0,170	7,93	5/16
VER-4006	0,246	9,52	3/8
VER-4008	0,435	12,70	1/2
VER-4011	0,680	15,87	5/8
VER-4017	1,742	25,40	1

Perfis Tabelados

Cantoneiras de abas desiguais

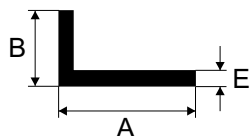

PERFIL	PESO LINEAR KG/M	MM			POLEGADA		
		A	B	E	A	B	E
L-001	0,118	25,00	11,00	1,30	-	-	-
L-093	0,300	25,40	12,70	3,17	1	1/2	1/8
L-581	0,160	32,00	16,20	1,20	-	-	-
L-100	0,521	38,10	25,40	3,17	1.1/2	1	1/8
L-23016	0,350	50,00	14,00	2	-	-	-
L-104	0,600	50,80	25,40	3,17	2	1	1/8
L-668	0,436	50,80	31,75	2,0	2	1.1/4	-
L-778	0,850	76,20	25,40	3,17	3	1	1/8
L-780	1,311	101,60	50,80	3,17	4	2	1/8

Cantoneiras de abas iguais

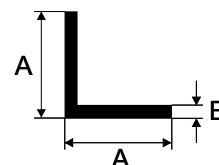

PERFIL	PESO LINEAR KG/M	MM		POLEGADA	
		A	E	A	E
L-641	0,073	12,70	1,10	1/2	-
L-002	0,100	12,70	1,58	1/2	1/16
L-643	0,076	15,87	1,00	5/8	-
L-405	0,130	15,87	1,58	5/8	1/16
L-644	0,092	19,05	1,00	3/4	-
L-009	0,150	19,05	1,58	3/4	1/16
L-011	0,300	19,05	3,17	3/4	1/8
L-642	0,122	25,40	1,00	1	-
L-013	0,210	25,40	1,58	1	1/16
L-014	0,410	25,40	3,17	-	1/8
L-015	0,598	25,40	4,76	1	3/16
L-3216	0,268	31,75	1,58	1.1/4	1/16
L-018	0,515	31,75	3,17	1.1/4	1/8
L-019	0,750	31,75	4,76	1.1/4	3/16
L-744	0,317	38,10	1,58	1.1/2	1/16
L-022	0,620	38,10	3,17	1.1/2	1/8
L-023	0,910	38,10	4,76	1.1/2	3/16
L-612	0,540	50,80	2,00	2	-
L-025	0,840	50,80	3,17	2	1/8
L-026	1,240	50,80	4,76	2	3/16
L-027	1,620	50,80	6,35	2	1/4
L-457	1,074	63,50	3,17	2.1/2	1/8
L-029	2,060	63,50	6,35	2.1/2	1/4
L-749	2,505	76,20	6,35	3	1/4

Perfis T

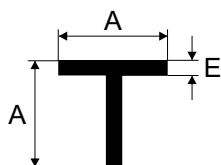

PERFIL	PESO LINEAR KG/M	MM		POLEGADA	
		A	E	A	E
T-002	0,100	12,70	1,58	1/2	1/16
T-123	0,162	25,40	1,20	1	-
T-076	0,213	25,40	1,58	1	1/16
T-021	0,633	38,10	3,17	1.1/2	1/8
T-023	0,845	50,80	3,17	2	1/8

Perfis U de abas iguais

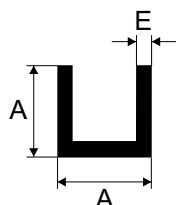

PERFIL	PESO LINEAR KG/M	MM		POLEGADA	
		A	E	A	E
U-841	0,084	9,52	1,20	3/8	-
U-036	0,108	9,52	1,58	3/8	1/16
U-1035	0,089	12,70	0,90	1/2	-
U-044	0,151	12,70	1,58	1/2	1/16
U-509	0,192	15,87	1,58	5/8	1/16
U-1582	0,234	22,22	1,30	7/8	-
U-245	0,320	25,40	1,58	1	1/16

Perfis U de abas desiguais

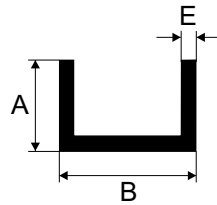

PERFIL	PESO LINEAR KG/M	MM			POLEGADA		
		A	B	E	A	B	E
U-786	0,100	12,70	9,52	1,20	1/2	3/8	-
U-037	0,130	12,70	9,52	1,58	1/2	3/8	1/16
U-056	0,200	12,70	19,05	1,70	1/2	3/4	-
U-1211	0,270	12,70	25,40	1,58	1/2	1	1/16
U-069	0,380	12,70	25,40	3,17	1/2	1	-
U-041	0,130	15,00	11,10	1,20	-	-	-
U-1178	0,135	15,00	14,00	1,20	-	-	-
U-627	0,200	19,05	12,70	1,58	3/4	1/2	1/16
VT-727	0,130	20,00	10,70	1,00	-	-	-
U-398	0,155	20,00	10,70	1,00	-	-	-
U-606	0,154	22,00	11,00	1,20	-	-	-
U-607	0,162	22,00	14,00	1,20	-	-	-
U-2514	0,165	25,00	14,00	1,00	-	-	-
U-555	0,230	25,00	15,00	1,35	-	-	-
U-087	0,810	25,40	50,80	3,17	1	2	1/8
U-091	1,030	25,40	76,20	3,17	1	3	1/8
PU-639	0,400	35,00	29,00	1,50	-	-	-
U-4814	0,360	48,00	14,40	1,35	-	-	-
U-093	1,680	50,80	101,60	3,17	2	4	1/8

Tubos Redondos

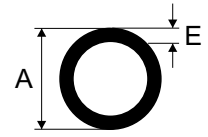

PERFIL	PESO LINEAR KG/M	MM		POLEGADA	
		A	E	A	E
TUB-001	0,074	9,52	1,00	3/8	-
TUB-003	0,108	9,52	1,58	3/8	1/16
TUB-008	0,100	12,70	1,00	1/2	-
TUB-009	0,121	12,70	1,24	1/2	-
TUB-018	0,160	15,87	1,24	5/8	-
TUB-026	0,155	19,05	1,00	3/4	-
TUB-027	0,184	19,05	1,24	3/4	-
TUB-030	0,426	19,05	3,17	3/4	1/8
TUB-036	0,183	22,22	1,00	7/8	-
TUB-038	0,282	22,22	1,58	7/8	1/16
TUB-045	0,254	25,40	1,24	1	-
TUB-046	0,320	25,40	1,58	1	1/16
TUB-048	0,600	25,40	3,17	1	1/8
TUB-053	0,364	28,57	1,58	1.1/8	1/16
TUB-058	0,405	31,75	1,58	1.1/4	1/16
TUB-061	0,770	31,75	3,17	1.1/4	1/8
TUB-069	0,494	38,10	1,58	1.1/2	1/16
TUB-070	0,942	38,10	3,17	1.1/2	1/8
TUB-Y0018	0,645	50,80	1,40	2	-
TUB-610	0,670	50,80	1,58	2	1/16
TUB-091	0,826	50,80	2,00	2	-
TUB-092	1,285	50,80	3,17	2	1/8
TUB-156	0,650	63,50	1,24	2.1/2	-
TUB-635	1,050	76,20	1,65	3	-
TUB-636	1,260	76,20	2,00	3	-
TUB-167	1,990	76,20	3,17	3	1/8
TUB-278	1,404	101,60	1,65	4	-

Tubos Quadrados

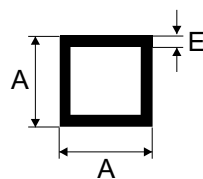

PERFIL	PESO LINEAR KG/M	MM		POLEGADA	
		A	E	A	E
TUB-4001	0,200	12,70	1,58	1/2	1/16
TUB-4002	0,250	15,87	1,58	5/8	1/16
TUB-4051	0,196	19,05	1,00	3,4	-
TUB-4003	0,297	19,05	1,58	3,4	1/16
TUB-4061	0,263	25,40	1,00	1	-
TUB-4008	0,405	25,40	1,58	1	1/16
TUB-4071	0,759	25,40	3,17	1	1/8
TUB-4046	1,127	30,00	4,00	-	-
TUB-4011	0,515	31,75	1,58	1.1/4	1/16
TUB-4064	0,486	38,10	1,20	1.1/2	-
TUB-4014	0,624	38,10	1,58	1.1/2	1/16

TUB-4015	0,780	38,10	3,17	1.1/2	-
TUB-4049	1,203	38,10	3,17	1.1/2	1/8
TUB-4120	0,850	50,80	1,58	2	1/16
TUB-4020	1,055	50,80	2,00	2	-
TUB-4048	1,640	50,80	3,17	2	1/8
TUB-4715	2,390	50,80	4,76	2	3/16
TUB-4033	1,610	76,20	2,00	3	-
TUB-4054	2,686	101,60	2,50	4	-
TUB-4025	4,015	101,60	3,80	4	-

Perfis Tabelados

Tubos retangulares

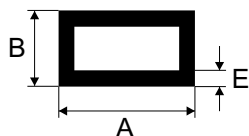

PERFIL	PESO LINEAR KG/M	MM			POLEGADA		
		A	B	E	A	B	E
TUB-4704	0,200	25,40	12,70	1,00	1	1/2	-
TUB-4501	0,310	25,40	12,70	1,58	1	1/2	1/16
TUB-4509	0,497	30,00	20,00	2,0	-	-	-
TUB-4710	0,430	38,10	19,05	1,45	1.1/2	3/4	-
TUB-4586	0,874	38,10	19,05	3,17	1.1/2	3/4	1/8
TUB-4545	0,645	38,10	25,40	2,00	1.1/2	1	-
TUB-4536	0,430	50,80	12,70	1,30	2	1/2	-
TUB-4588	0,410	50,80	25,40	1,00	2	1	-
TUB-4560	0,630	50,80	25,40	1,50	2	1	-
TUB-4504	0,810	50,80	25,40	2,00	2	1	-
TUB-4589	1,201	50,80	25,40	3,17	2	1	1/8
TUB-4718	0,700	50,80	38,10	1,40	2	1.1/2	-
TUB-4513	0,918	50,80	38,10	2,00	2	1.1/2	-
TUB-4543	0,875	60,32	38,10	1,70	2.3/8	1.1/2	-
TUB-4707	0,983	76,20	38,10	1,50	3	1.1/2	-
TUB-4517	1,190	76,20	38,10	2,00	3	1.1/2	-
TUB-4518	1,858	76,20	38,10	3,17	3	1.1/2	1/8
TUB-4573	2,076	76,20	50,80	3,17	3	2	1/8
TUB-4537	1,760	101,60	38,10	2,40	4	1.1/2	-
TUB-4730	1,225	101,60	50,80	1,50	4	2	-
TUB-4599	1,770	101,60	50,80	2,00	4	2	-
TUB-4530	2,500	101,60	50,80	3,17	4	2	1/8
TUB-4520	3,181	152,40	38,10	3,20	6	1.1/2	1/8
TUB-4559	3,206	152,40	50,80	3,00	6	2	-
TUB-4728	4,566	152,40	76,20	3,50	6	3	-

Chapa lisa em alumínio

2000 X 1000 mm		2000 X 1250 mm		3000 X 1000 mm	
ESP.	PESO	ESP.	PESO	ESP.	PESO
0,50	2,700	0,60	4,050	0,70	7,087
0,60	3,240	0,70	4,725	1,00	10,125
0,70	3,780	0,80	5,400	1,20	12,150
0,80	4,320	1,00	6,750	1,50	15,187
1,00	5,400	1,20	8,100	2,00	20,250
1,20	6,480	1,50	10,125	3,00	30,375
1,50	8,100	2,00	13,500		
2,00	10,800	3,00	20,250		
2,50	13,500	4,00	27,00		
3,00	16,200				
4,00	21,600				

Chapa xadrez

2500 X 1000 mm	
ESP.	PESO (KG)
1,20	11,50
2,20	18,50
2,70	23,00

3000 X 1250 mm	
ESP.	PESO (KG)
1,20	19,00

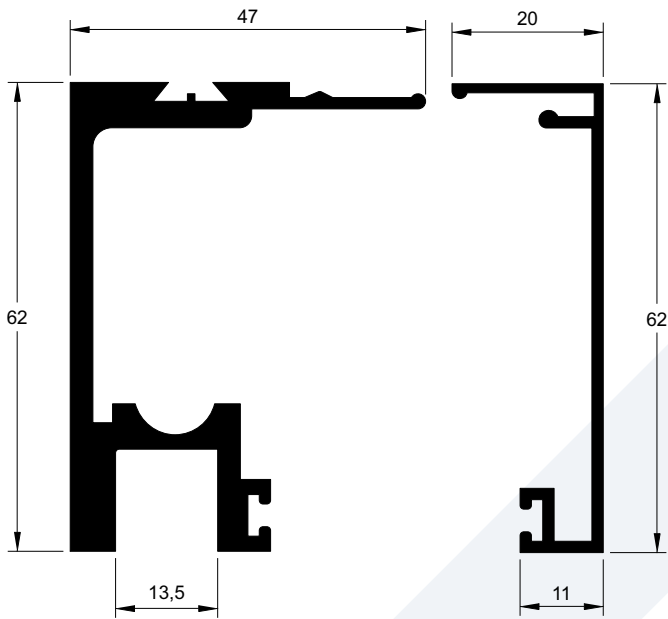

L-713

1,272 kg/m

E-512

0,390 kg/m

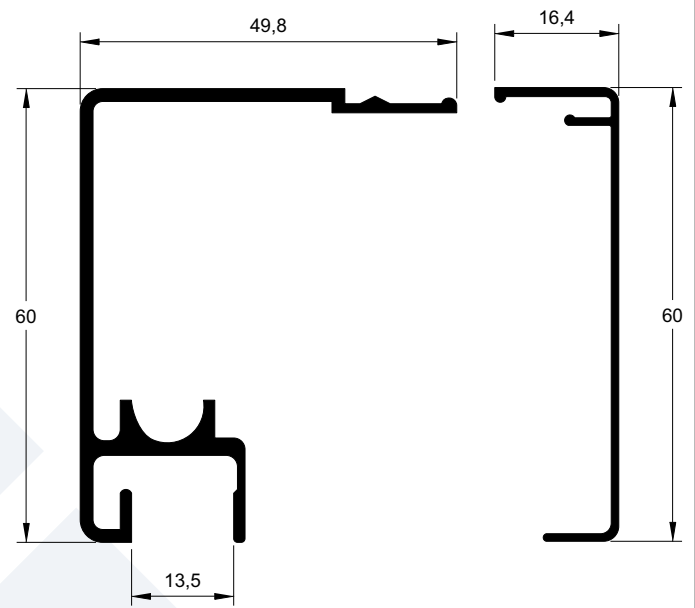

Y-839

0,760 kg/m

U-1319

0,240 kg/m

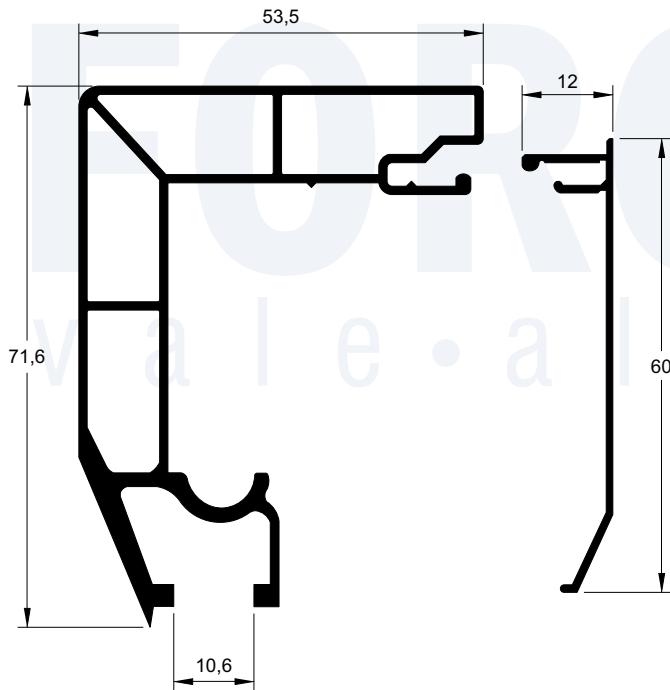

VT-2065

0,978 kg/m

VT-2514

0,203 kg/m

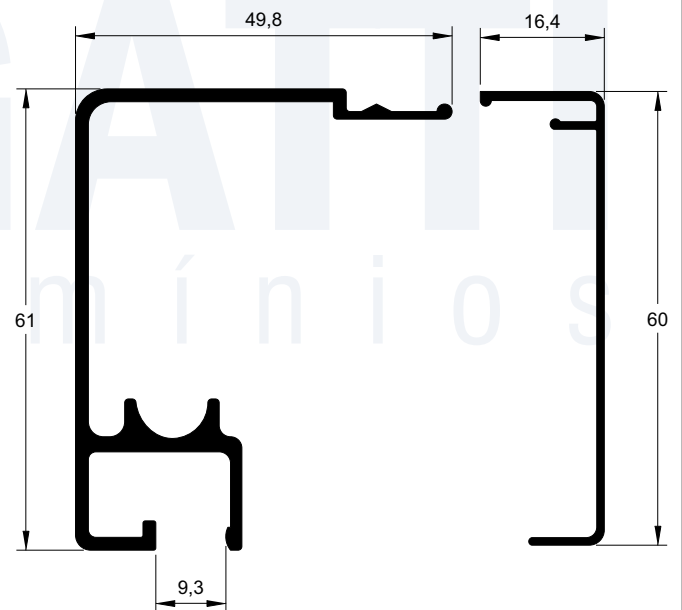

VT-3419

0,686 kg/m

U-1319

0,240 kg/m

Vidro Temperado

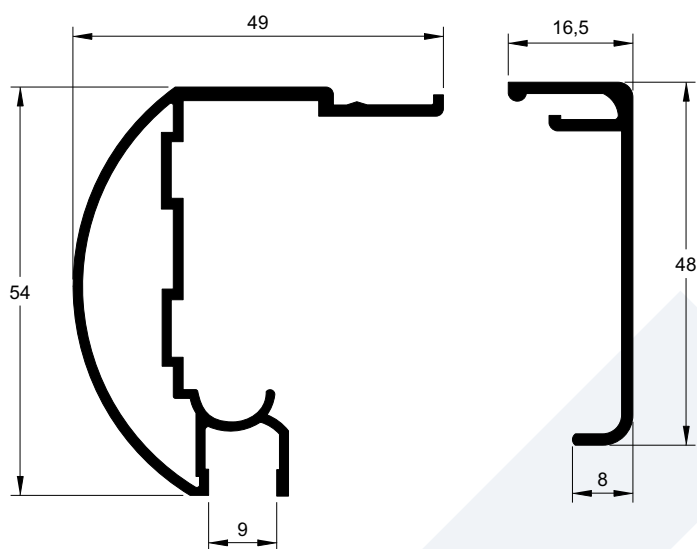

VT-106

0,600 kg/m

VT-102

0,220 kg/m

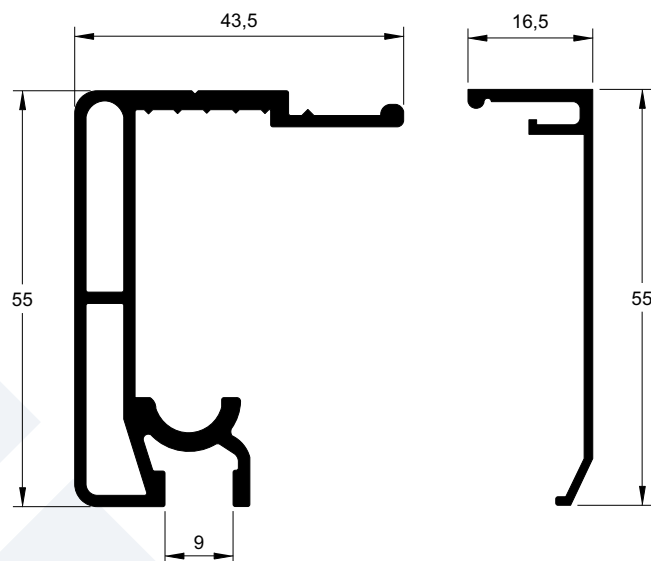

VT-2548

0,725 kg/m

VT-3281

0,257 kg/m

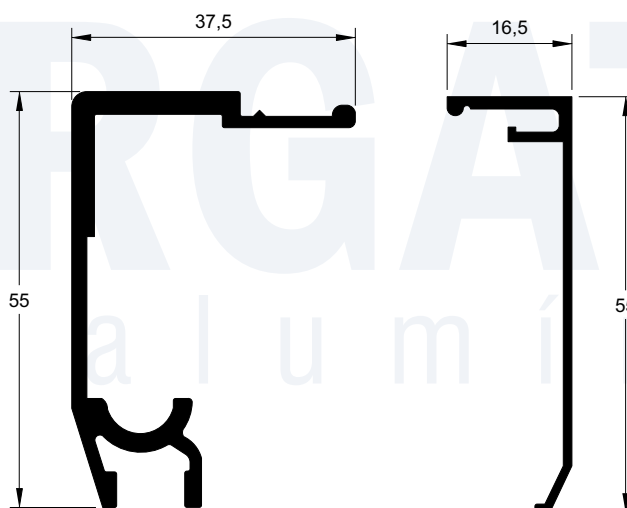

VT-145

0,687 kg/m

VT-3281

0,257 kg/m

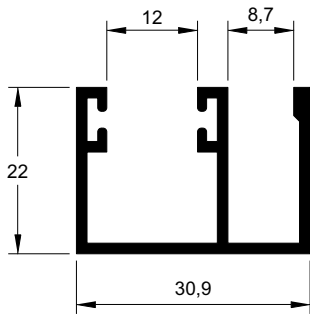

VT-161

0,383 kg/m

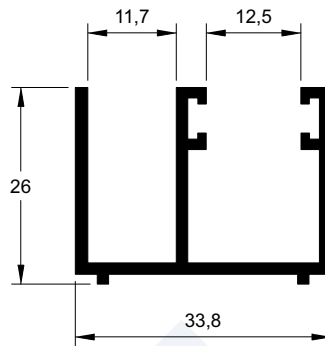

E-637A

0,385 kg/m

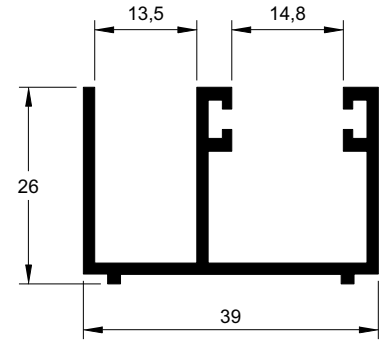

E-306

0,450 kg/m

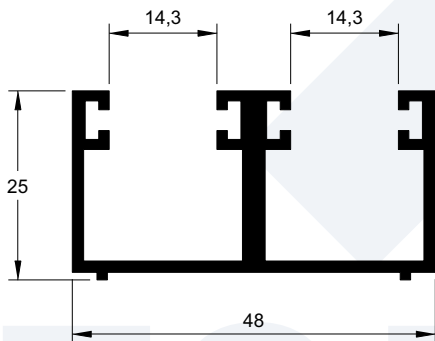

E-725

0,600 kg/m

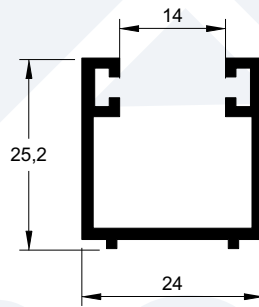

U-1108

0,370 kg/m

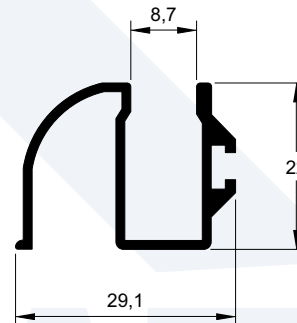

VT-2296

0,277 kg/m

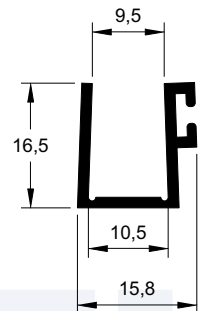

VT-2445

0,176 kg/m

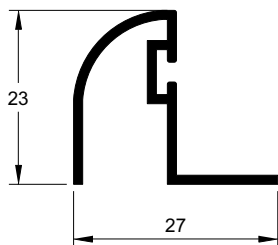

VT-108

0,220 kg/m

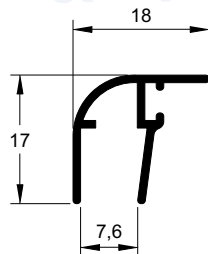

VT-215

0,157 kg/m

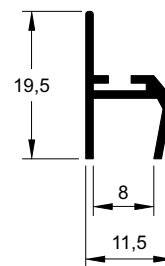

VT-107

0,150 kg/m

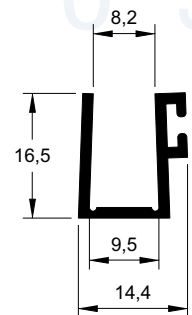

VT-2344

0,172 kg/m

Vidro Temperado

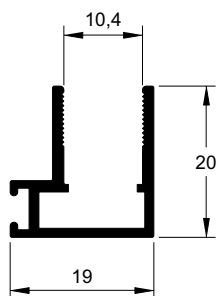

U-1014

0,245 kg/m

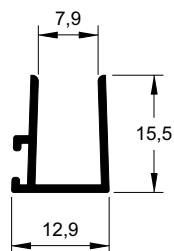

VT-480

0,130 kg/m

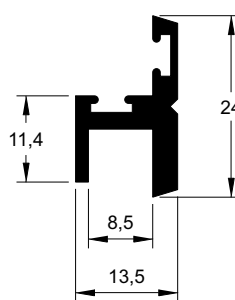

Y-344

0,250 kg/m

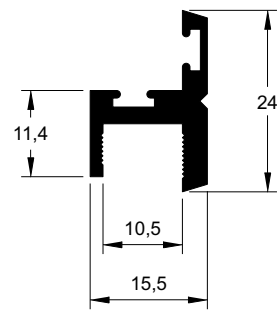

Y-343

0,290 kg/m

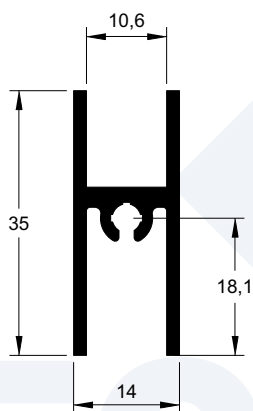

I-083

0,430 kg/m

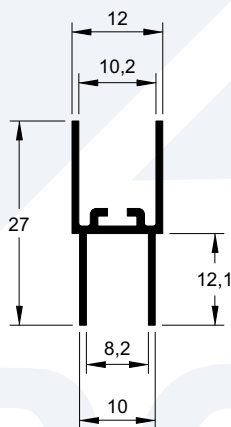

BX-2899

0,385 kg/m

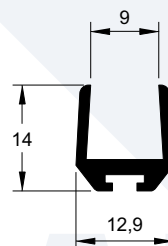

U-566

0,160 kg/m

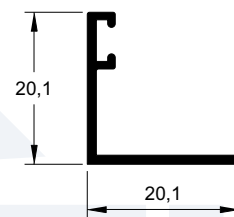

BX-2900

0,127 kg/m

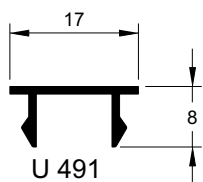

U 491

U-491

0,097 kg/m

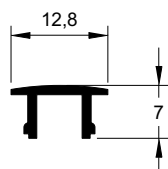

VT-104

0,060 kg/m

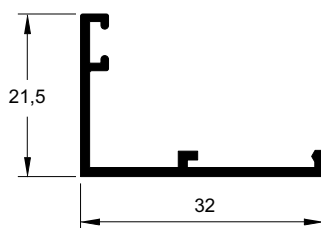

L-1000

0,270 kg/m

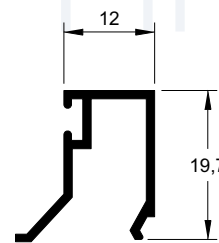

BG-1000

0,190 kg/m

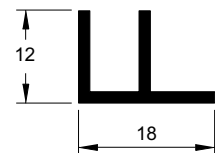

F-049

0,120 kg/m

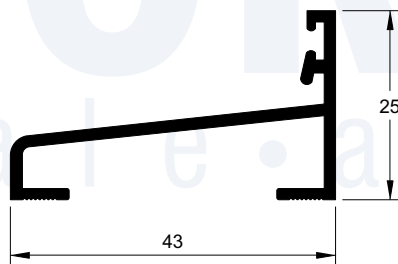
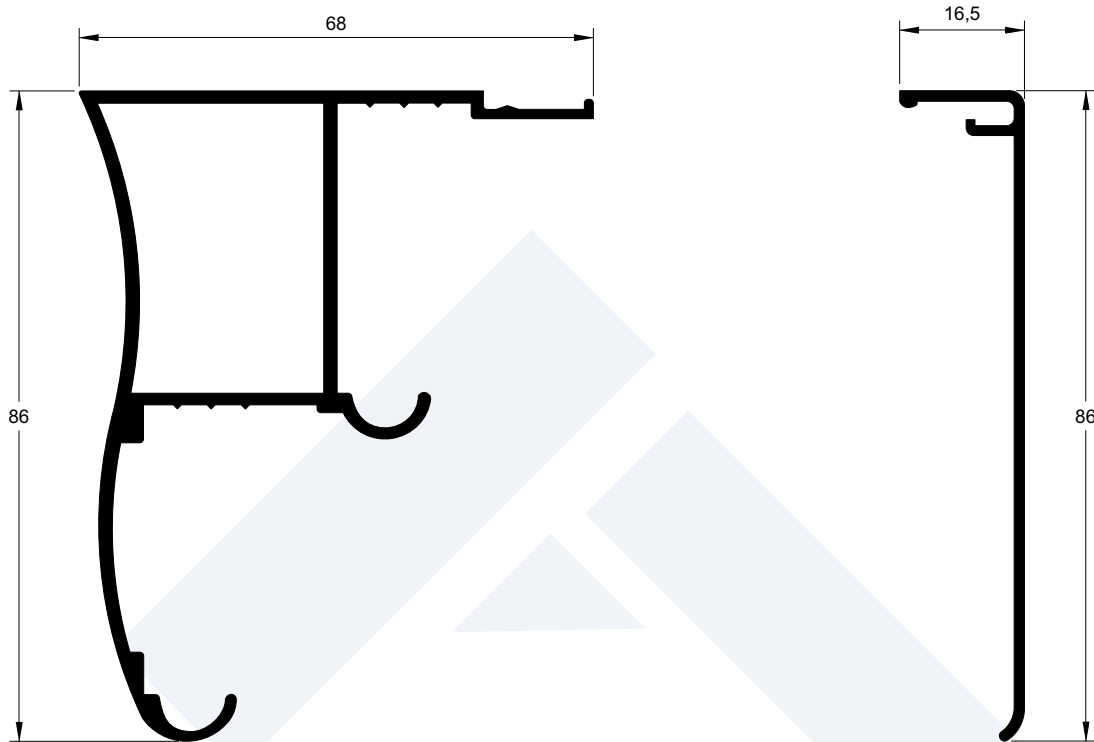

TAMANHOS DISPONÍVEIS - 2 FOLHAS MOVEIS

1,20 m

1,50 m

Vidro Temperado

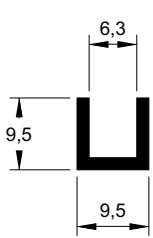

U-036

0,108 kg/m

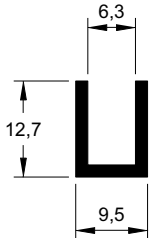

U-037

0,130 kg/m

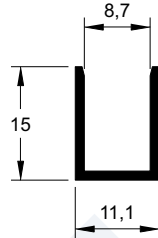

U-041

0,130 kg/m

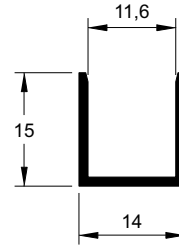

U-1178

0,135 kg/m

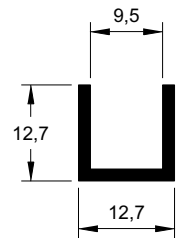

U-044

0,151 kg/m

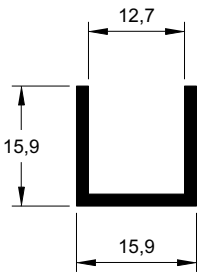

U-509

0,192 kg/m

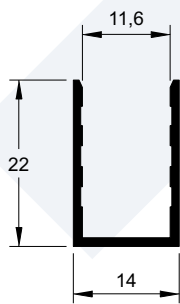

U-607

0,162 kg/m

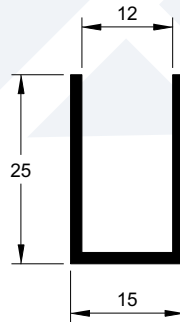

U-555

0,230 kg/m

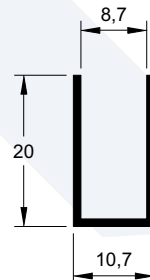

VT-727

0,130 kg/m

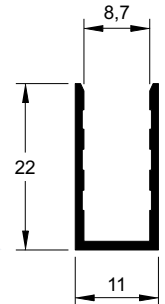

U-606

0,154 kg/m

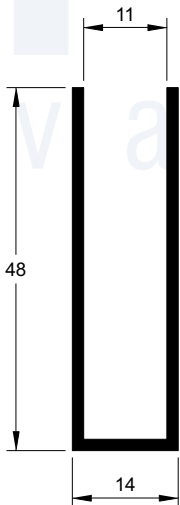

U-4814

0,360 kg/m

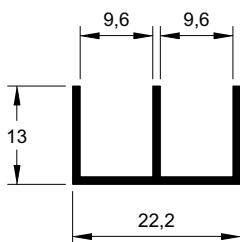

E-168

0,160 kg/m

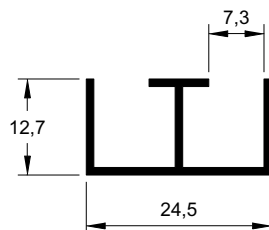

VIT-24

0,190 kg/m

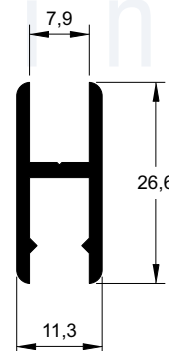

VIT-23

0,273 kg/m

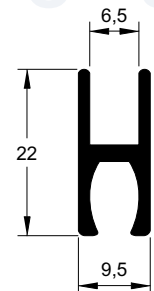

I-151

0,170 kg/m

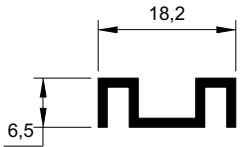

E-252

0,140 kg/m

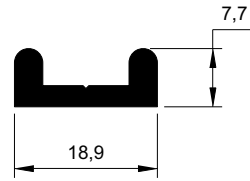

VIT-26

0,195 kg/m

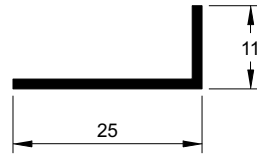

L-001

0,118 kg/m

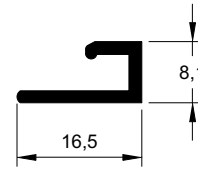

L-392

0,084 kg/m

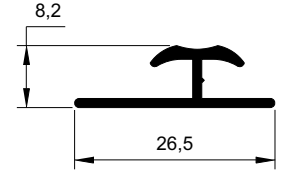

I-301

0,162 kg/m

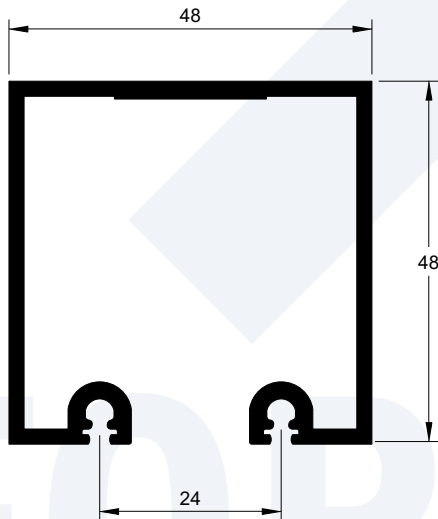

VT-3836

0,874 kg/m

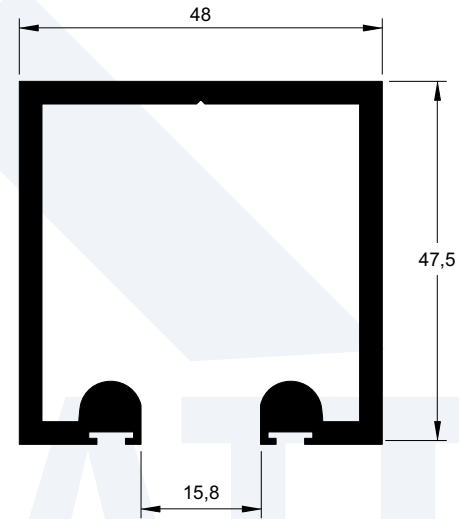

U-4848

1,500 kg/m

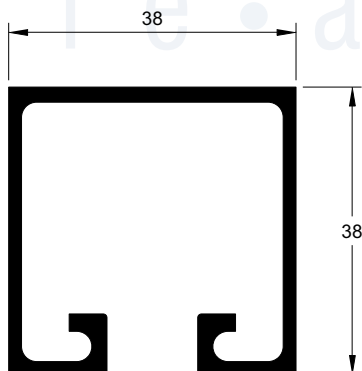

U-163

0,827 kg/m

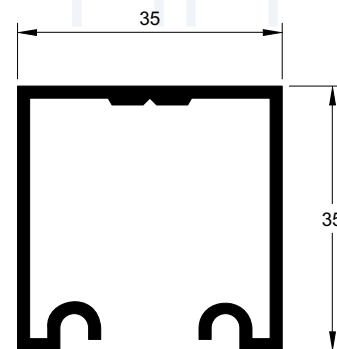

U-1098

0,494 kg/m

Gradil

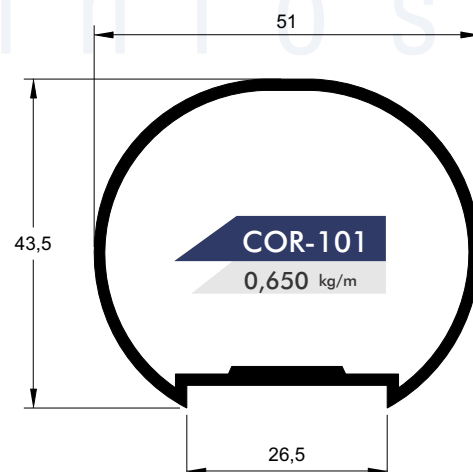
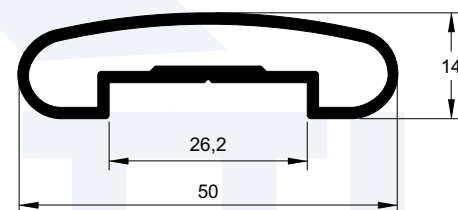
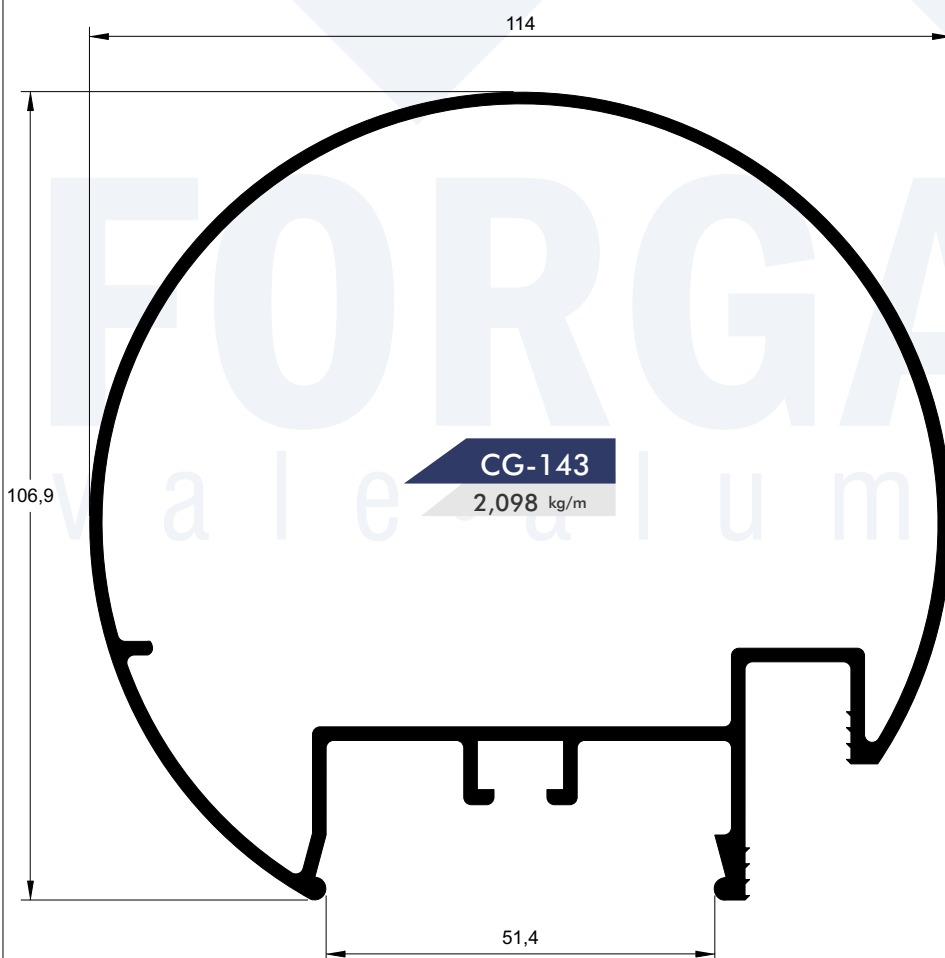
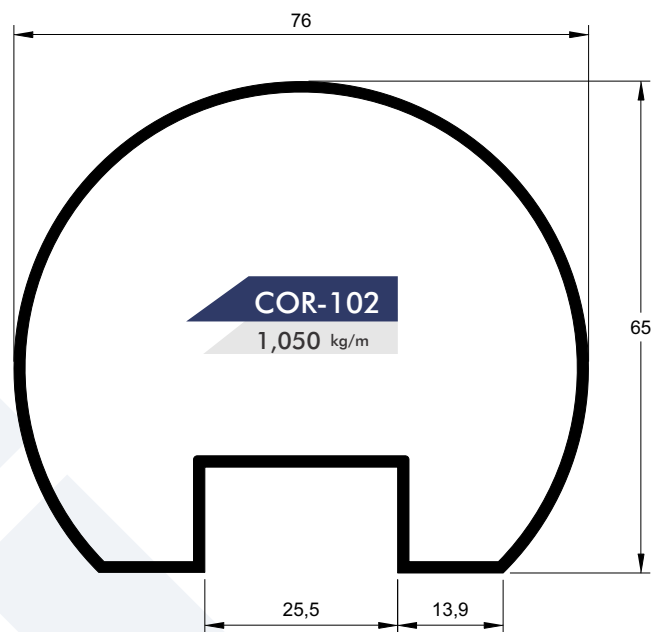
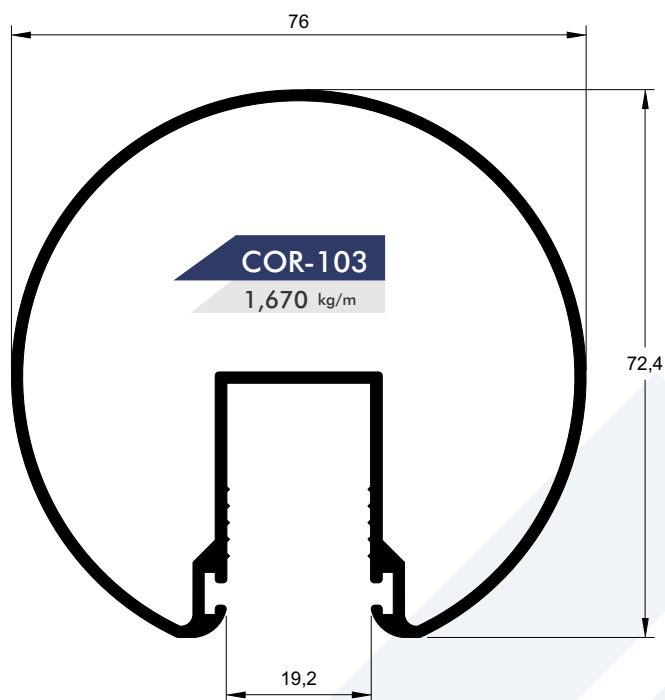

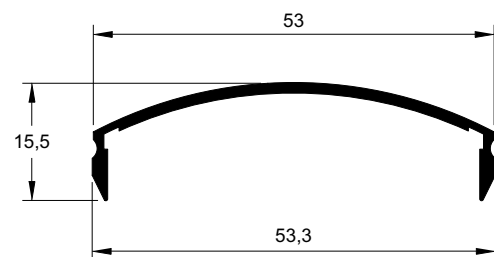
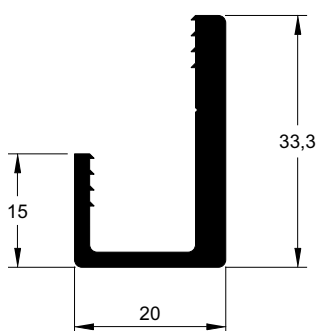
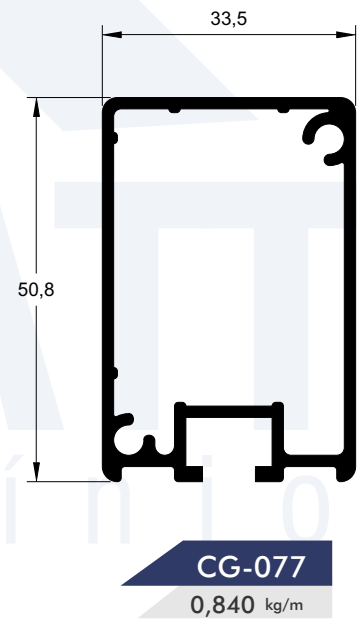
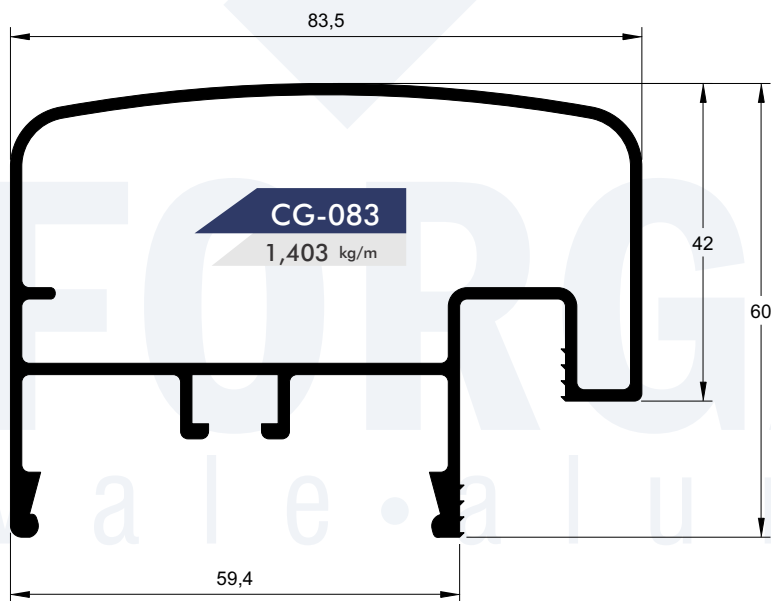
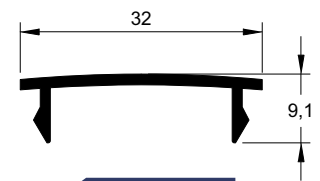
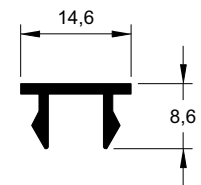
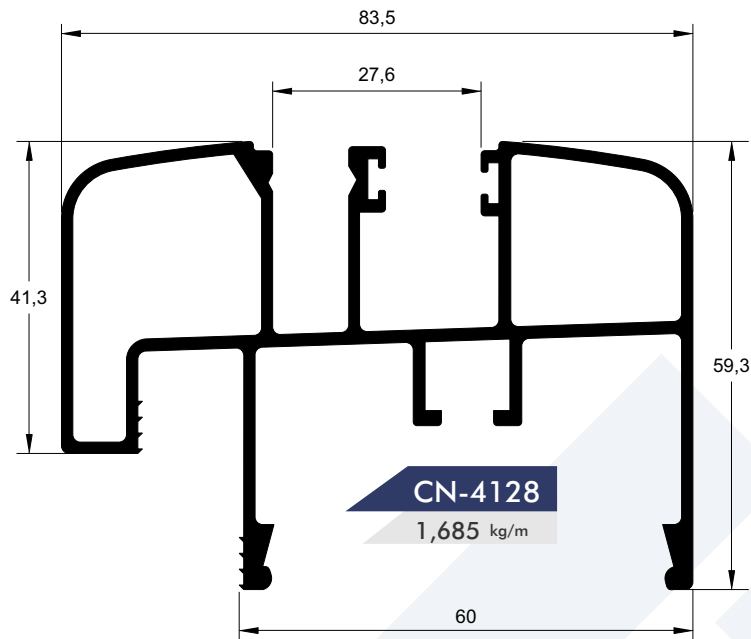

Gradil

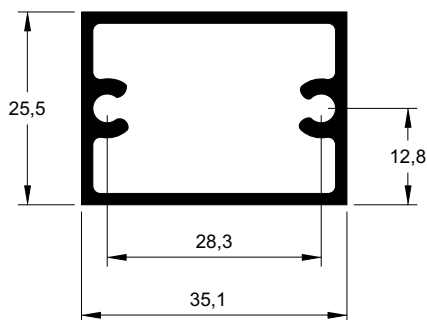
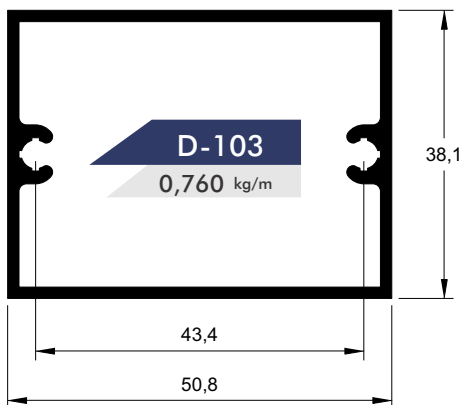
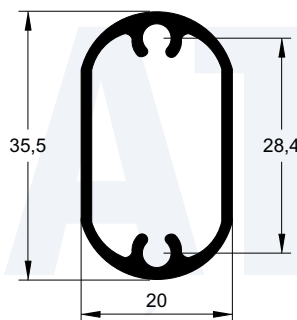
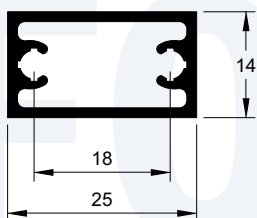
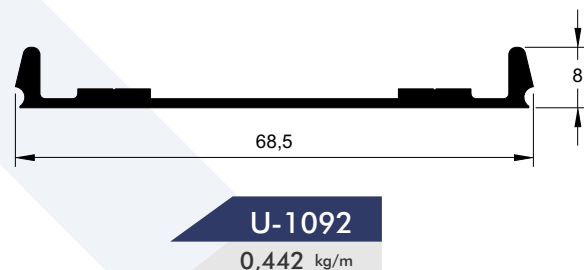
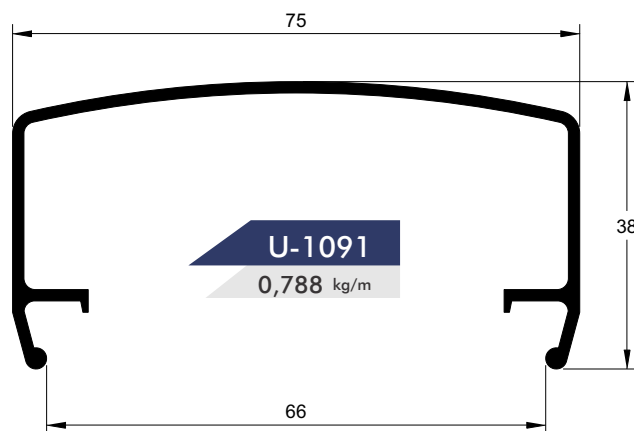
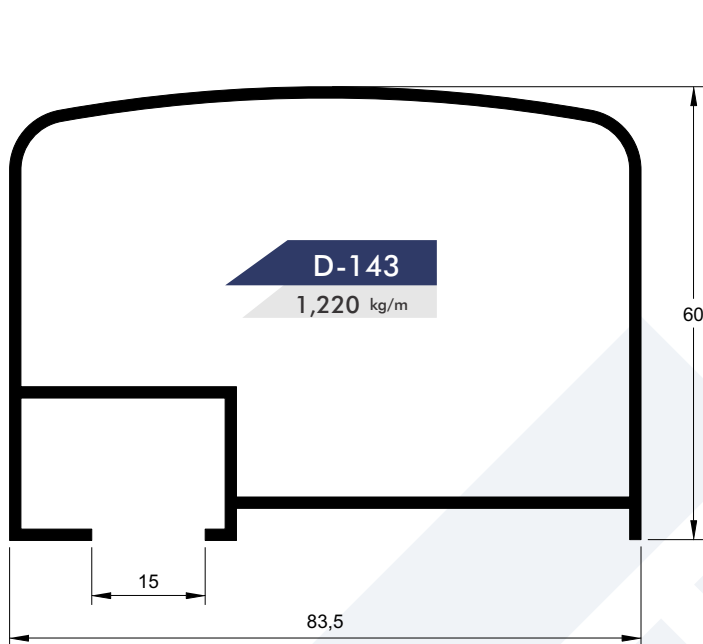

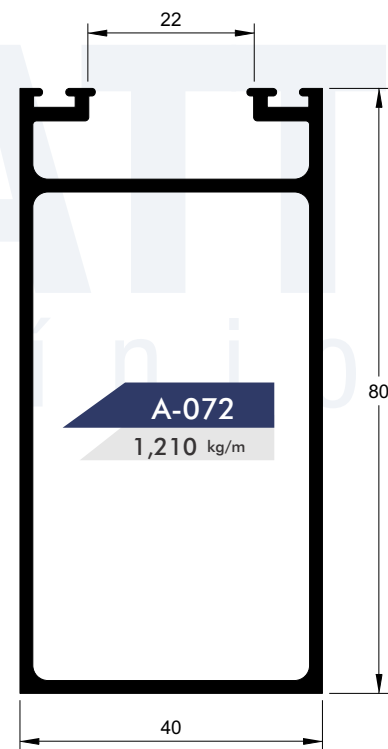
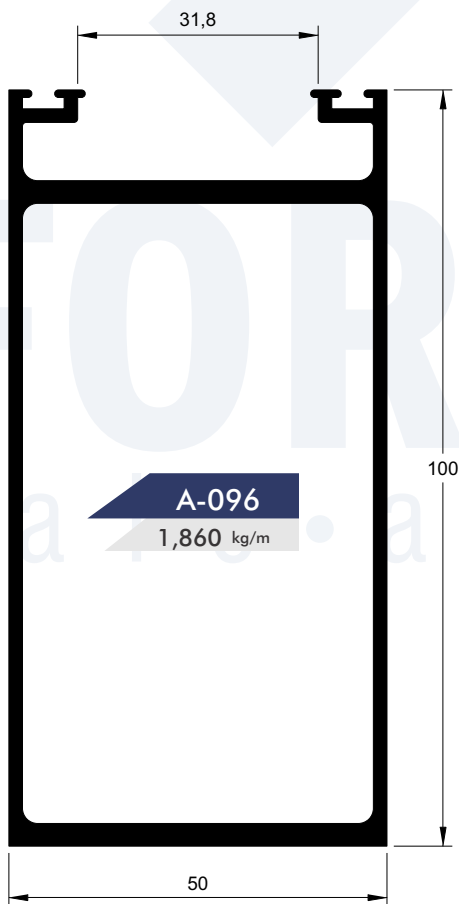
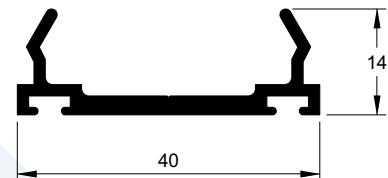
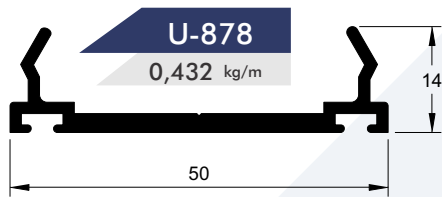
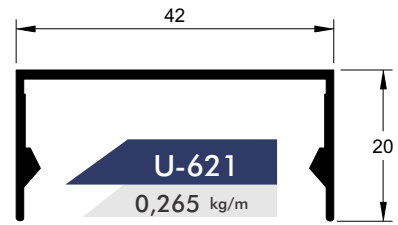
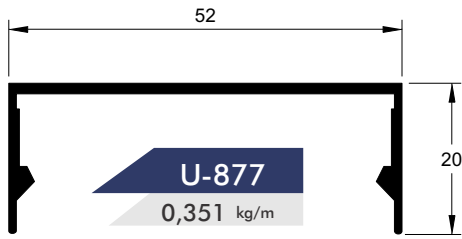

PERFIS BOX LISO E FRISADO

PERFIS PARA ESQUADRIAS, FACHADAS E OUTROS

CHAPA EM ALUMÍNIO / ACM

CHAPAS, TELHAS E VENEZIANA EM POLICARBONATO

KIT DE FERRAGENS PARA PORTÕES BASCULANTE

ACESSÓRIOS * COMPONENTES

ESCOVAS DE VEDAÇÃO

GUARNIÇÕES EM EPDM

PARAFUSOS * BUCHAS * REBITES

KITS PARA BOX



FORGATTI
vale.alumínios

Rua Koichi Matsumura, 132 - Jardim América - São José dos Campos / SP

CEP 12235-180 - TEL (12) 3931-3937

e-mail: forgattivale@uol.com.br - www.forgatti.com.br